

SERRA CON APERTURE LATERALI

MODELLO A CASETTA - LARGHEZZA 3,00 M

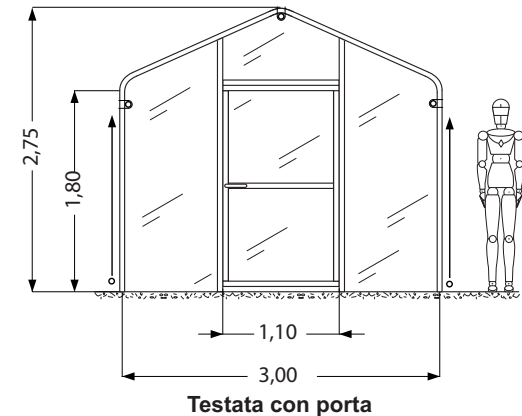

Testata con porta

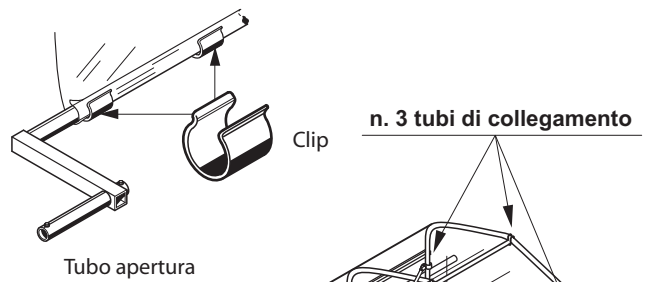

n. 3 tubi di collegamento

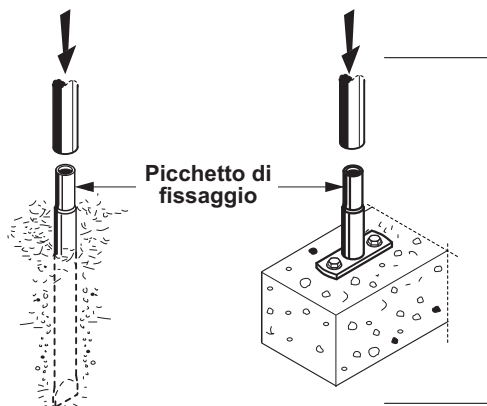

Standard

Opzione

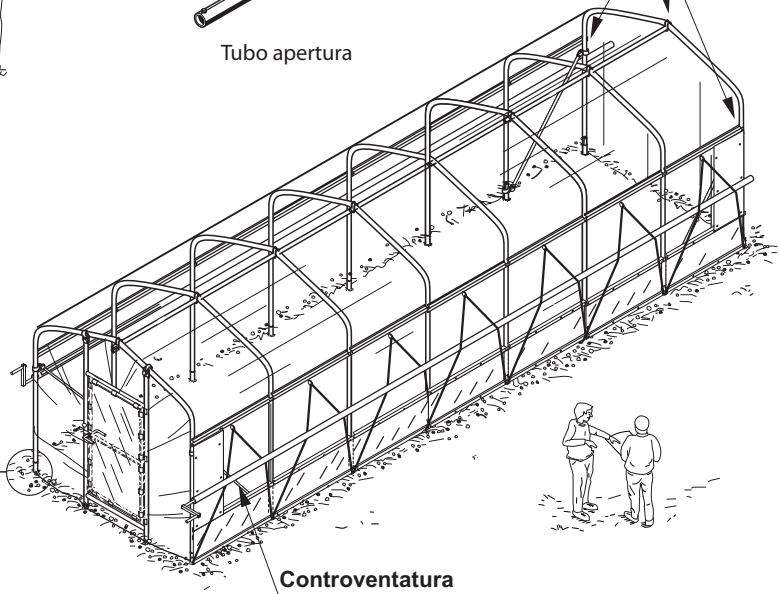

MODELLO AD ARCO - LARGHEZZA 4,50 M

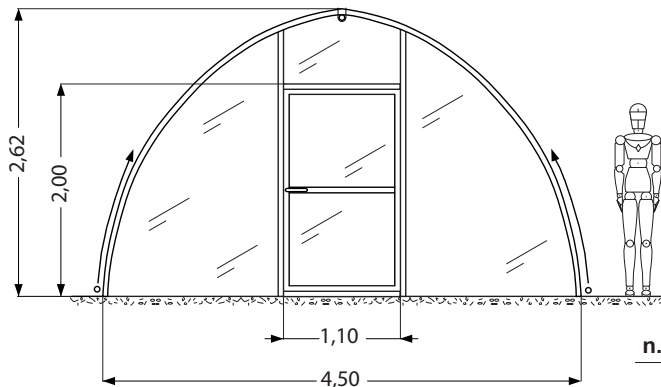

Testata con porta

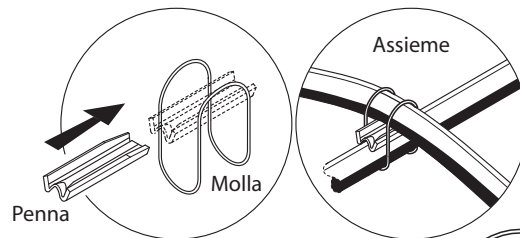

n. 1 tubo di collegamento

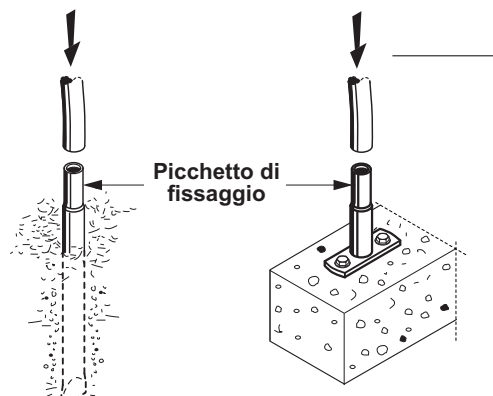

Standard

Opzione

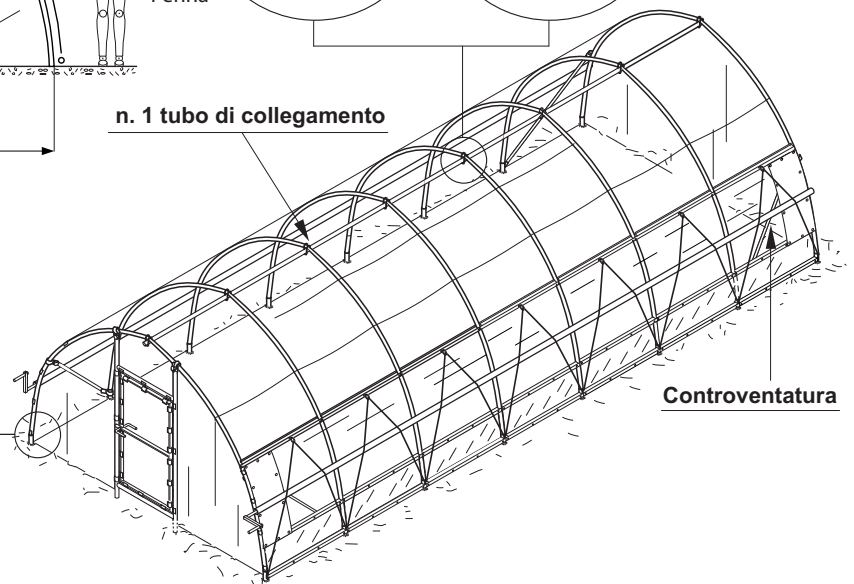

**LOMBARDA
SERRE**

LOMBARDA SERRE S.n.c.
Via Prà delle Vigne - Grantola (VA) ITALIA
Tel 0332-576556 - Fax 0332-576770
e-mail: info@lombardaserre.it